



Multi-Tire TPMS Solution T201 / T401 / HT series



Orange Electronic Inc.
P:+1-310-377-8835 F:+1-310-377-8875
Toll Free:+1-855-OEC-TPMS

Orange Electronic Co., Ltd.
T:+886-4-2535 1558 F:+886-4-2535 1582
sales@orange-electronic.com

<http://www.orange-electronic.com>

ABOUT ORANGE

- Orange = O - range = wireless technology



**Zero-range
between your
car and sensors**



Contact us soon

P: +1-310-377-8835
F: +1-310-377-8875
Toll Free: +1-855-OEC-TPMS

CERTIFICATION

- Save property, save fuel, save life.



AUTOMATIC PRODUCTION LINE

- Racing car reliability tested
- Decent quality
- TS16949 certificated

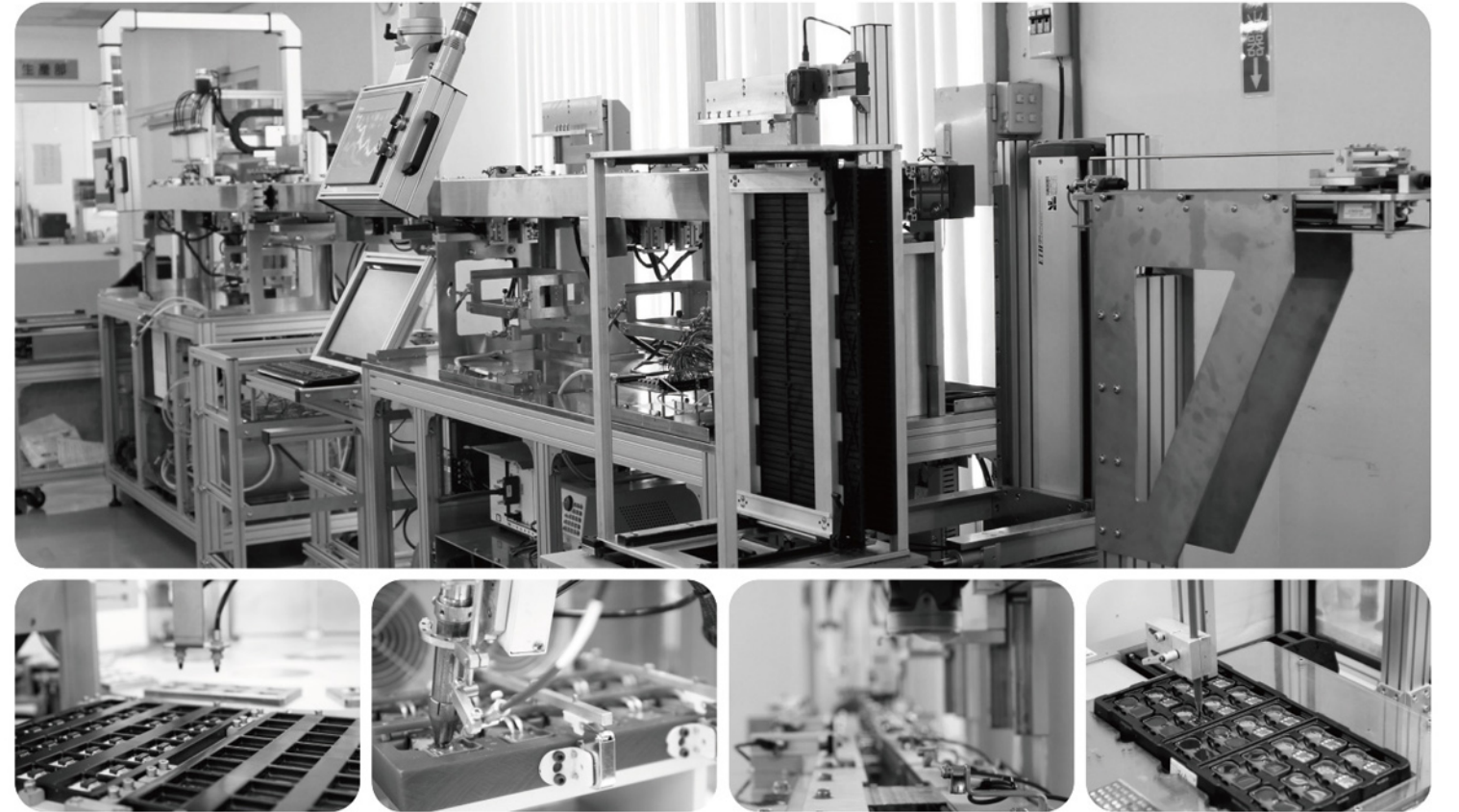

Caravan and Commercial vehicle solution HT

- Save property, save fuel, save life.

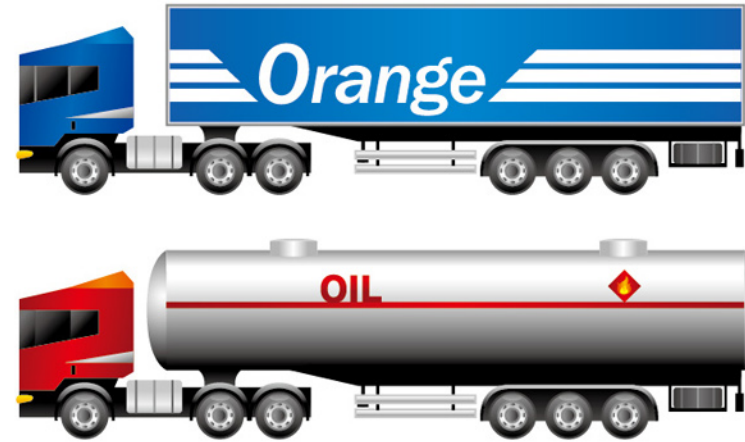

- Lower the odds of tire blowouts > (No. 1 reason for truck to call road service)
- 250,000 accidents caused by low tire pressure in U.S
- Under-inflated tires require longer stopping distance.

T201 / T401

- T201 / T401

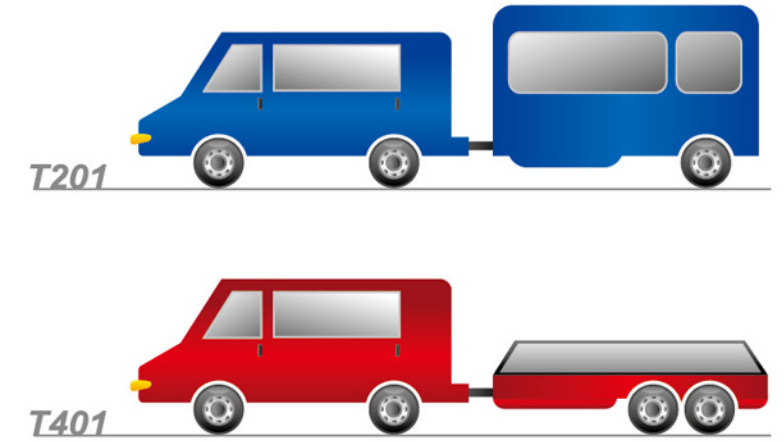

- Lower the odds of tire blowouts > (No. 1 reason for truck to call road service)
- 250,000 accidents caused by low tire pressure in U.S
- Under-inflated tires require longer stopping distance.

BUS

- Win passenger trust with no accidents
- Easy installation, simple functionality.

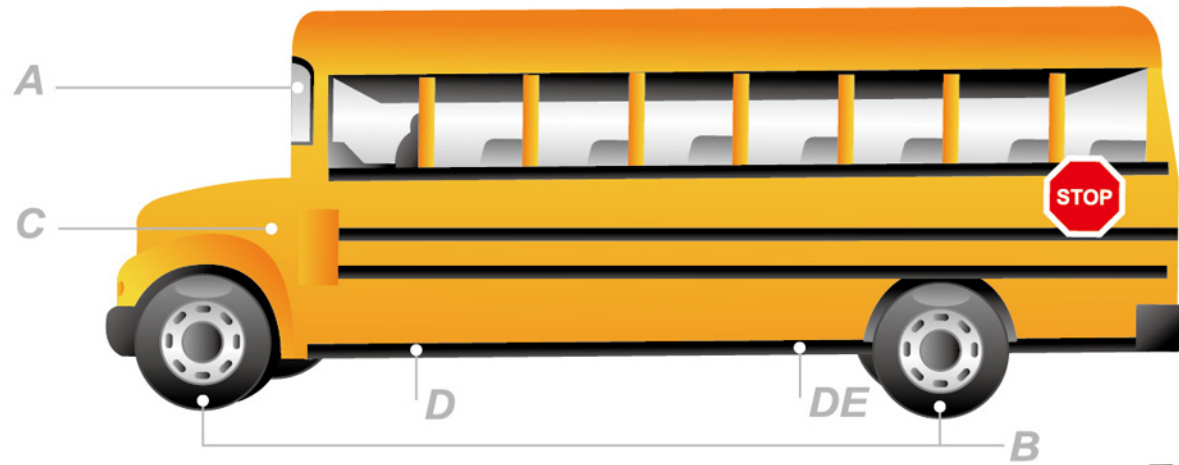

A Display



B Sensor



C Master Control Box



D Receiver

E Network-End Indicator

Save property, Save fuel, Save life

Advanced Canbus System (BUS)

- Make your passenger much more comfortable.
- Compatible with multi-tires.

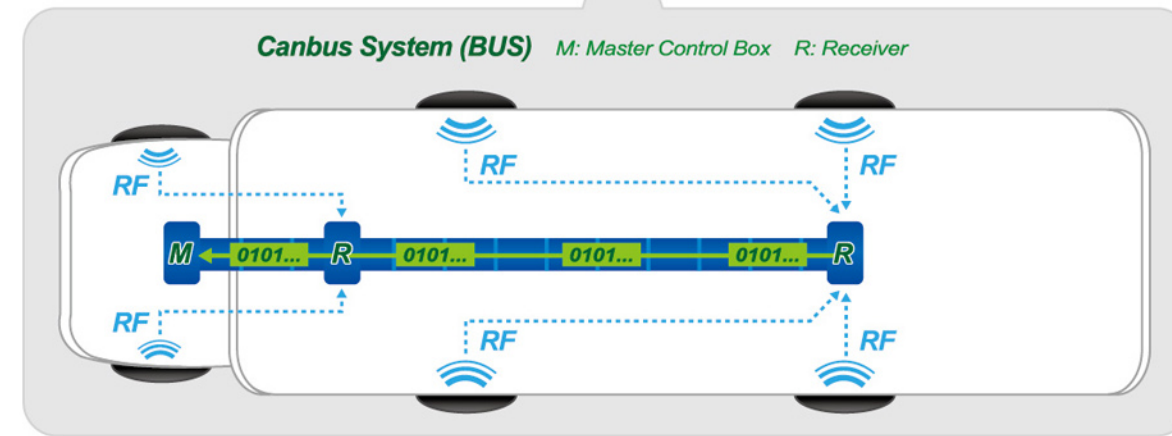
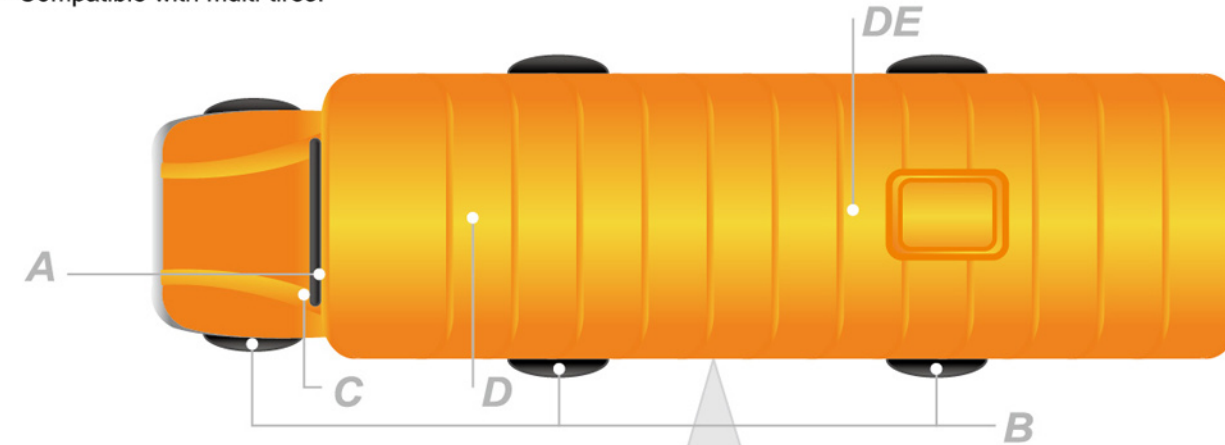

TRUCK

- Fuel saving = money saving
- High quality of Canbus system.

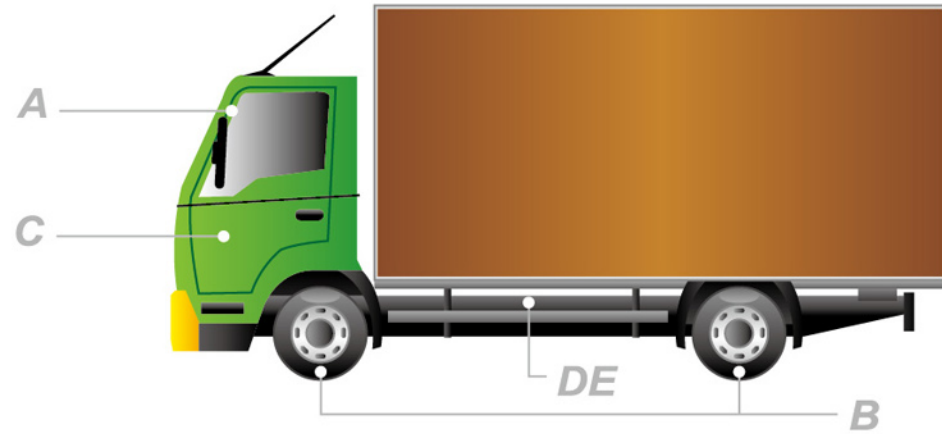

A Display



B Sensor



C Master Control Box



D Receiver



E Network-End Indicator

Save property, Save fuel, Save life

Advanced Canbus System (TRUCK)

- Protect your goods and investment.
- High efficiency of transmission rate.

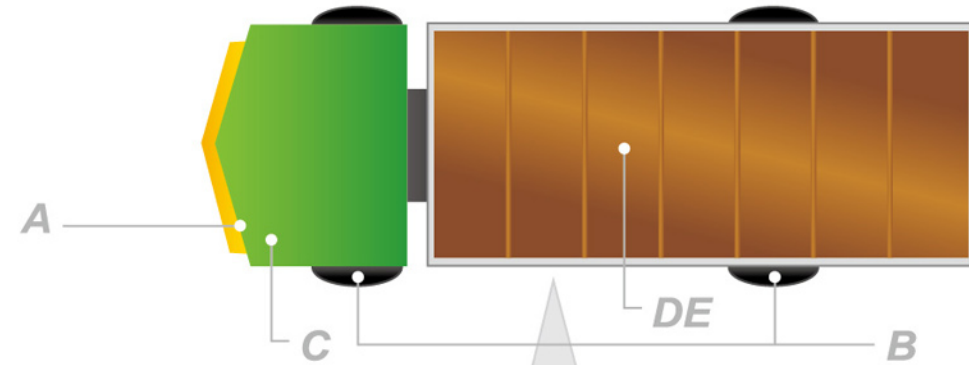

Canbus System (TRUCK) M: Master Control Box R: Receiver

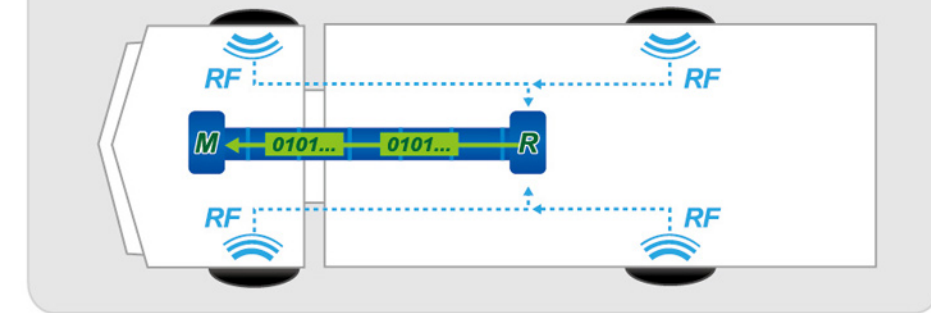

MULTI-TIRES

- Lower the odds of tire blowouts.
- Save your load goods.



A Display



B Sensor



C Master Control Box



D Slaver Control Box **E** Receiver



F Network-End Indicator

Save property, Save fuel, Save life

Advanced Canbus System (MULTI-TIRES)

- Most efficient Canbus system.
- High quality battery (-40°C~125°C)

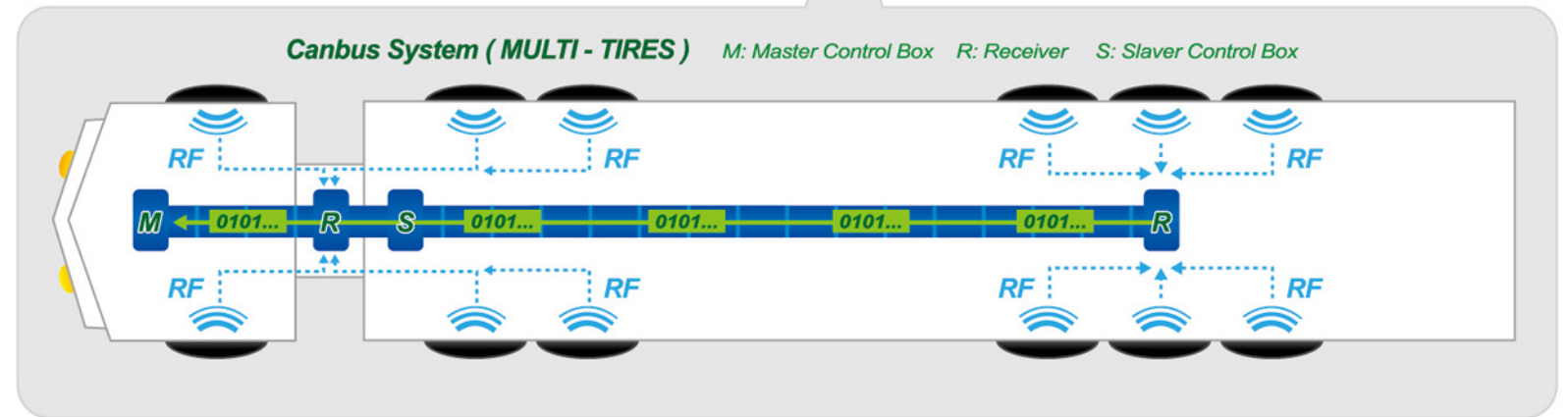
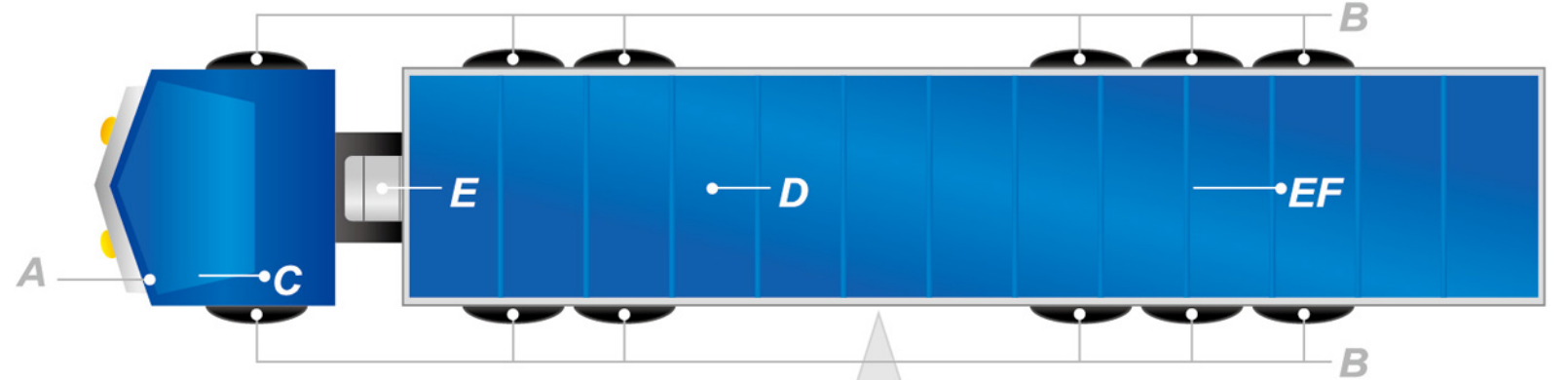

TRAILER / BOAT

- Make your luxury goods much saver.
- Easy installation, sample functionality.

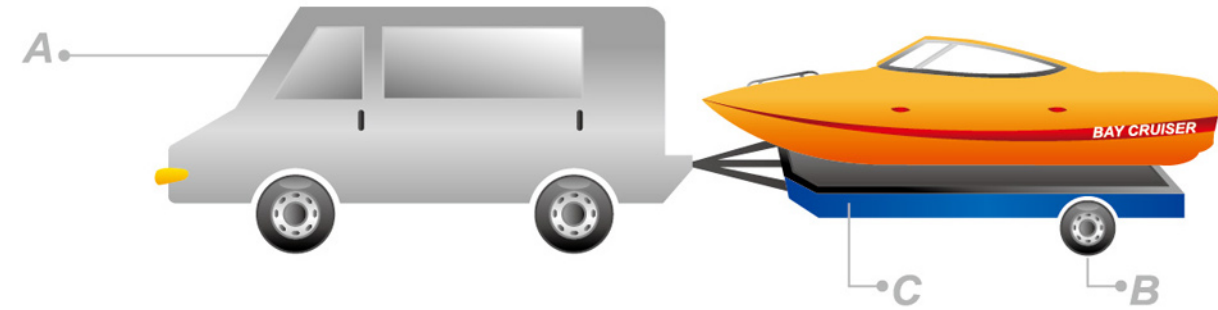

A Display



B Sensor



C Relay

Save property, Save fuel, Save life

TRAILER

- Fuel Saving= Money Saving
- High Quality Battery (-40°C~125°C)

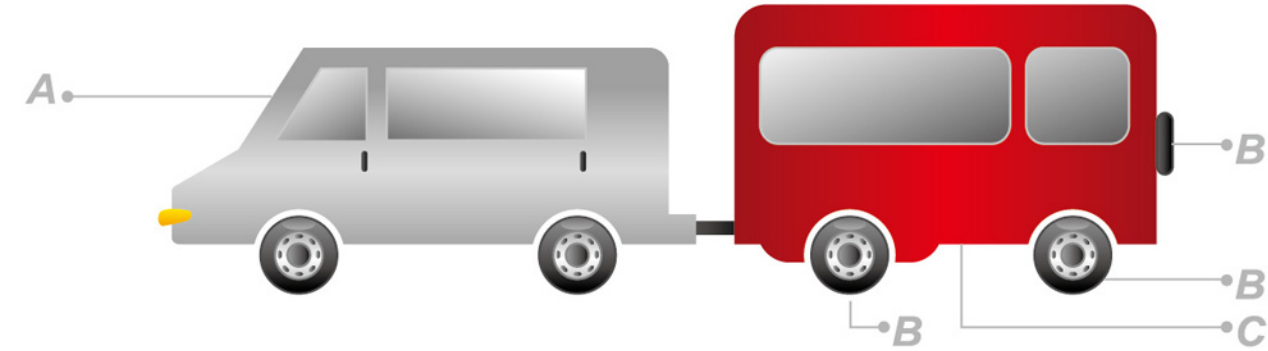

A Display



B Sensor



C Relay

Save property, Save fuel, Save life

Specifications / T201 / T401 / HT series

Product Model	Product Photo	Sensor's Photo	Pressure Monitoring Range	Battery Operating Temperature
T201			0-170 psi	-40 °C to 125 °C
T401			0-170 psi	-40 °C to 125 °C
HT series			0-188 psi	-40 °C to 125 °C



Orange provides completed concept of multi-tires TPMS solution.
Save property, save fuel, save life.

Customer list

BRIDGESTONE



CONTACT US



Orange Electronic Inc.
P:+1-310-377-8835 F:+1-310-377-8875
Toll Free:+1-855-OEC-TPMS



Orange Electronic Co., Ltd.
T:+886-4-2535-1558 F:+886-4-2535-1582
sales@orange-electronic.com



Orange · JAPAN Inc.
T:+81-3-5368-1566 F:+81-3-5368-1585
info@ojtpms.co.jp

